



# MK11A Bluetooth Module

Datasheet

# Contents

1. Product Instruction	1
1.1 Key Features	1
1.2 Applications	2
1.3 Product Specifications	3
2. Block Diagram	5
3. Mechanical specifications	6
3.1 Module Mechanical Dimensions	6
3.2 Recommended PCB land pads	7
4. Pin Assignment	8
5. Mounting Suggestion	10
6. Cautions	14
6.1 Reflow Soldering	14
6.2 Usage Condition Notes	15
6.3 Storage Notes	16
Revision History	16

## 1. Product Instruction

**MK11A** is a low-cost and low-power consumption **Bluetooth®** module based on **Texas Instruments CC2642R SoC** solution, which has a powerful 48-MHz Arm® Cortex™-M4F processor supporting Bluetooth® 5.1 Low Energy and Proprietary 2.4 GHz applications.

The system CPU is the foundation of a high-performance, low-cost platform that meets the system requirements of minimal memory implementation, and low-power consumption, while delivering outstanding computational performance and exceptional system response to interrupts.

**MK11A** has a size of 25mm x 17mm x 2.8mm with 36 pins providing 30 GPIOs and integrates a high-performance PCB trace antenna.

### 1.1 Key Features

- **Bluetooth 5.1 features**
  - LE 2M PHY (High Speed)
  - LE Coded PHYs (Long Range)
  - Multiple Advertisement Sets
  - CSA#2
  - Direction finding (AoA)
- **Microcontroller**
  - Powerful 48-MHz Arm® Cortex®-M4F processor
  - EEMBC CoreMark® score: 148
  - 352KB of in-system Programmable Flash
  - 256KB of ROM for protocols and library functions
  - 8KB of Cache SRAM (Alternatively available as general-purpose RAM)
  - 80KB of ultra-low leakage SRAM. The SRAM is protected by parity to ensure high reliability of operation.
  - Supports Over-the-Air upgrade (OTA)
- **Ultra-low power sensor controller with 4KB of SRAM**
  - Sample, store, and process sensor data
  - Operation independent from system CPU
  - Fast wake-up for low-power operation

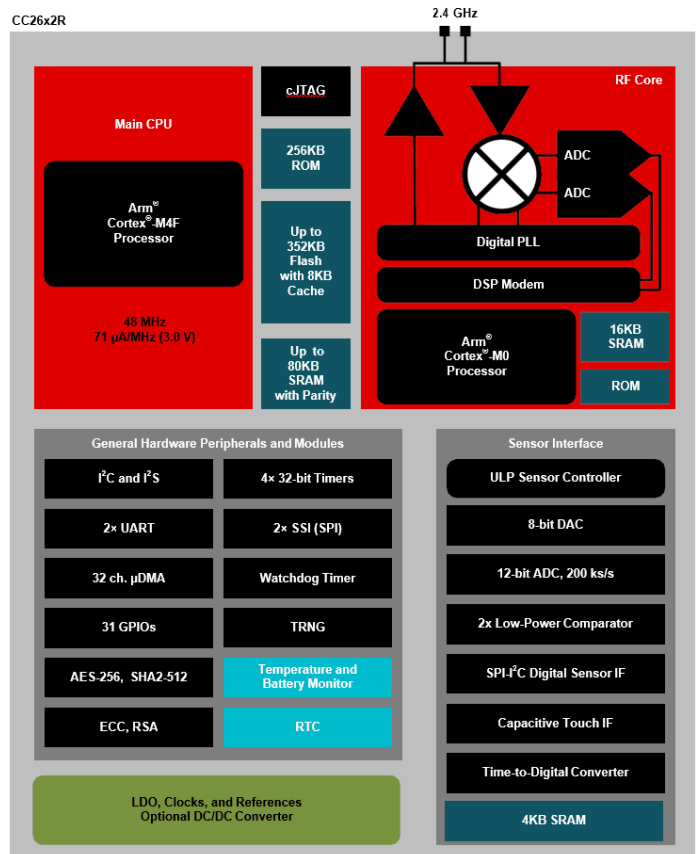

## 1.2 Applications

- **IoT**
  - Home automation
  - Sensor networks
  - Building automation
  - Industrial automation
- **Personal area networks**
  - Health/fitness sensor and monitor devices
  - Medical devices
  - Key fobs and wrist watches
- **Interactive entertainment devices**
  - Remote controls
  - Gaming controllers
  - VR/AR
- **Beacons**
- **Remote control toys**
- **Computer peripherals and I/O devices**
  - Mouse
  - Keyboard
  - Multi-touch trackpad
  - Gaming

### 1.3 Product Specifications

Detail	Description
<b>Bluetooth</b>	
Features	Bluetooth® Low Energy Bluetooth® Mesh Direction finding (AoA) LE 1M PHY LE 2M PHY LE Coded PHY (Long Range) Advertising Extensions CSA #2
Security	AES 128- and 256-bit Crypto Accelerator
LE connections	Concurrent central, observer, peripheral, and broadcaster roles with up to twenty concurrent connections along with one observer and one broadcaster
<b>Low Power</b>	
Active-Mode RX	6.9 mA
Active-Mode TX 0 dBm	7.3 mA
Active-Mode TX 5 dBm	9.6 mA
Active-Mode MCU 48 MHz (CoreMark)	3.4 mA (71µA/MHz)
Sensor Controller Low Power-Mode, 2 MHz running infinite loop	30.1µA
Sensor Controller Active-Mode, 24 MHz running infinite loop	808µA
Standby	0.94µA (RTC on, 80KB RAM and CPU retention)
Shutdown	150nA (wakeup on external events)
<b>Radio</b>	
Frequency	2360MHz - 2500MHz
Modulations	GFSK at 1Mbps, 2Mbps data rates
Transmit power	+5 dBm maximum
Receiver sensitivity	-105 dBm for Bluetooth 125kbps (LE Coded PHY) -97 dBm for 1Mbps PHY
Antenna	PCB trace antenna
Advertising distance @1Mbps (Open area)	More than 115 meters
<b>Mechanical design</b>	
Dimensions	Length: 25mm±0.2mm Width: 17mm±0.2mm Height: 2.8mm+0.1mm/-0.15mm
Package	36 Plated Half-hole pins
PCB material	FR-4
Impedance	50Ω

# MK11A Bluetooth Module

## Datasheet

Detail	Description
<b>Hardware</b>	
Peripherals	2× UART 2× SSI (SPI, MICROWIRE, TI) I <sup>2</sup> C I <sup>2</sup> S 8 x 12bit ADC, 200k Samples/s, 8 channels 4x 32bit or 8x16bit general-purpose timers Programmable current source 30 GPIOs 2× DAC (1× continuous time, 1× ultra-low power) Real-Time Clock (RTC) ECC and RSA Public Key Hardware Accelerator SHA2 Accelerator (Full suite up to SHA-512) True Random Number Generator (TRNG) Capacitive sensing, up to 8 channels Integrated temperature and battery monitor
Power supply	1.8 V to 3.8 V
Operating temperature range	-40 to 85°C (-40 to +105 °C can be customized)
Clock control	32.768 kHz +/-20 ppm crystal oscillator
Power regulator	DC/DC converter enabled
<b>Certifications</b>	
USA (FCC)	FCC part 15 modular certification 47 CFR Part 15, Subpart C FCC ID: 2AO94-MK11
Europe (CE)	EN 300 328 V2.2.2      3.2: Effective use of spectrum allocated EN 301 489-1 V2.2.3    3.1(b): Electromagnetic Compatibility EN 301 489-17 V3.2.4 EN 62368-1: 2014+A11:2017    3.1(a): Health and Safety of the user EN 62479: 2010

## 2. Block Diagram

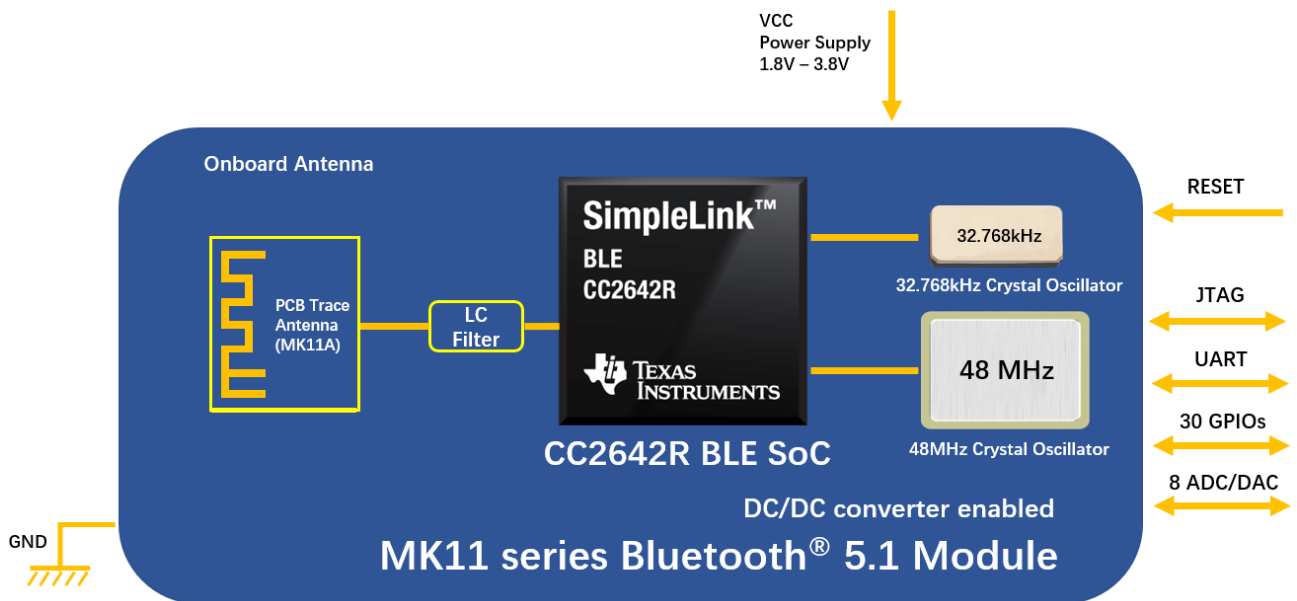

### 3. Mechanical specifications

#### 3.1 Module Mechanical Dimensions

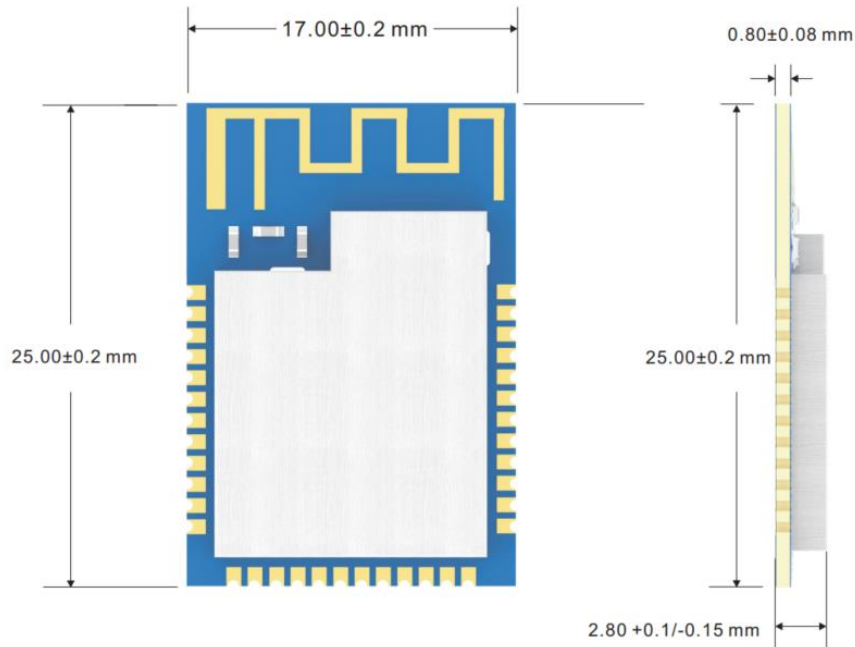

Symbol	Min.	Typ.	Max.
Length	-0.2mm	25mm	+0.2mm
Width	-0.2mm	17mm	+0.2mm
Height (PCB only)	-0.08mm	0.8mm	+0.08mm
Height (with shield)	-0.15mm	2.8mm	+0.1mm



### 3.2 Recommended PCB land pads

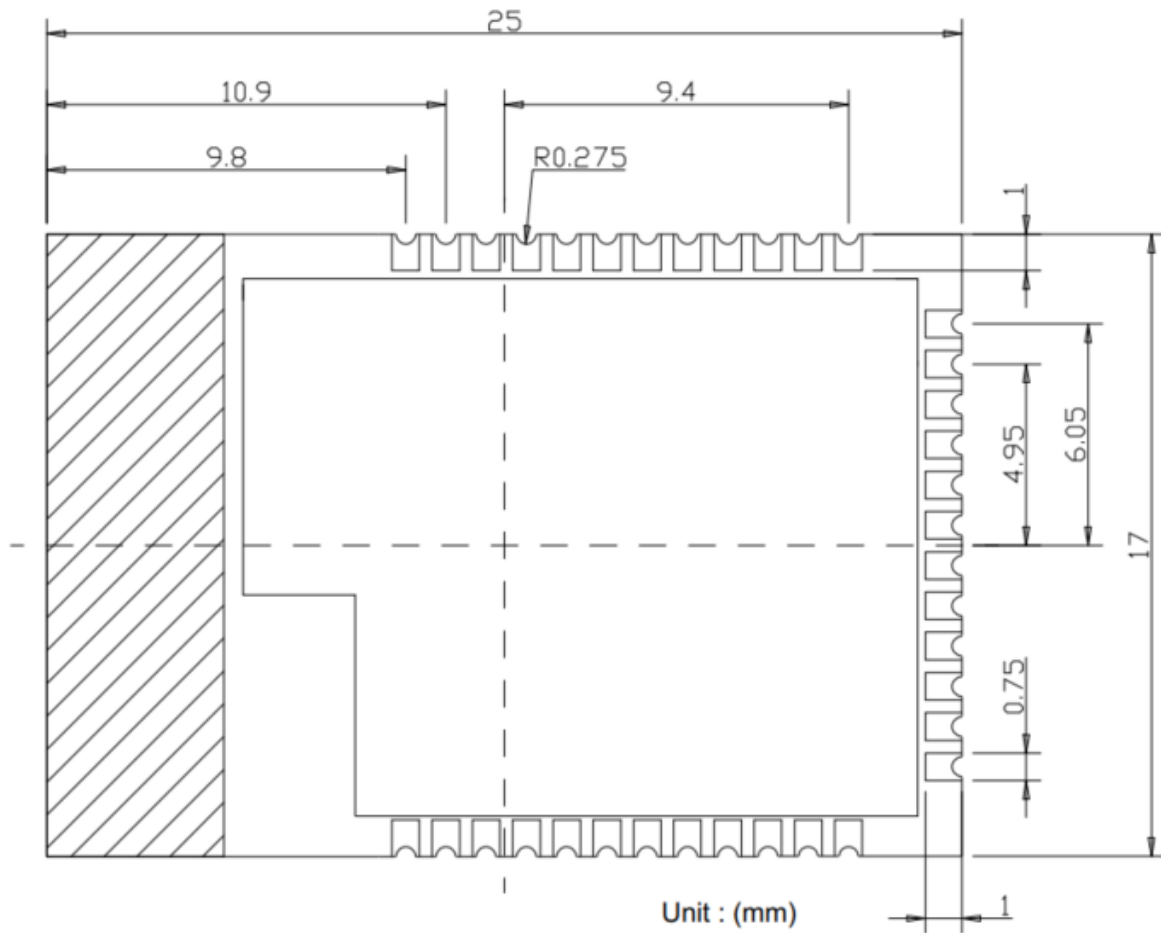

**MK11A PCB land pads (TOP View)**

Symbol	Typ.
Pad (Bottom)	0.75mm x 1.00mm
Diameter of Half-hole	0.55mm

### 4. Pin Assignment

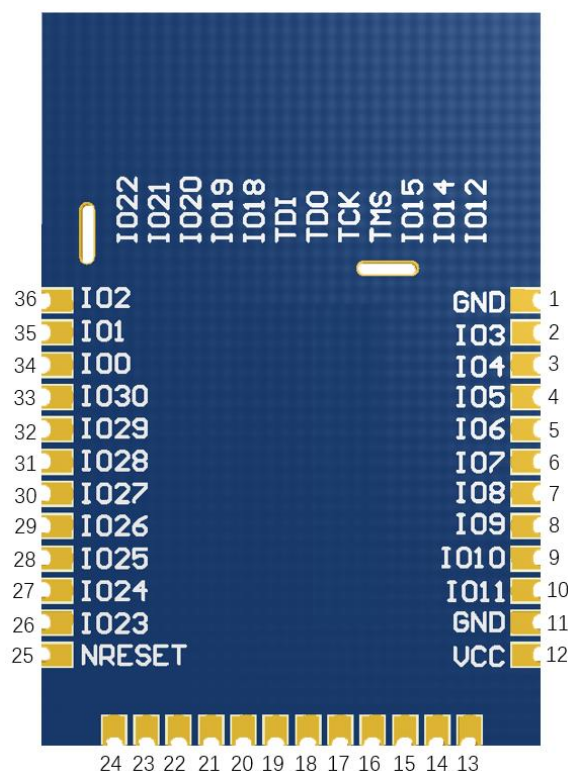

**MK11A module pin diagram (Rear View)**

Pin No.	Name	Type	Description
1	GND	Power	Ground
2	IO3	Digital I/O	General purpose I/O
3	IO4	Digital I/O	General purpose I/O
4	IO5	Digital I/O	General purpose I/O high-drive capability
5	IO6	Digital I/O	General purpose I/O high-drive capability
6	IO7	Digital I/O	General purpose I/O high-drive capability
7	IO8	Digital I/O	General purpose I/O
8	IO9	Digital I/O	General purpose I/O
9	IO10	Digital I/O	General purpose I/O
10	DIO11	Digital I/O	General purpose I/O
11	GND	Power	Ground
12	VCC	Power	1.8V-3.8V supply
13	IO12	Digital I/O	General purpose I/O
14	IO14	Digital I/O	General purpose I/O
15	IO15	Digital I/O	General purpose I/O
16	TMS	Digital I/O	JTAG TMS, high-drive capability

# MK11A Bluetooth Module

## Datasheet

Pin No.	Name	Type	Description
17	TCK	Digital Input	JTAG TCKC
18	TDO	Digital I/O	General purpose I/O JTAG_TDO, high-drive capability
19	TDI	Digital I/O	General purpose I/O JTAG_TDI, high-drive capability
20	IO18	Digital I/O	General purpose I/O
21	IO19	Digital I/O	General purpose I/O
22	IO20	Digital I/O	General purpose I/O
23	IO21	Digital I/O	General purpose I/O
24	IO22	Digital I/O	General purpose I/O
25	NRESET	Digital Input	Reset, active low. No internal pullup resistor
26	IO23	Digital I/O Analog	General purpose I/O Analog capability
27	IO24	Digital I/O Analog	General purpose I/O Analog capability
28	IO25	Digital I/O Analog	General purpose I/O Analog capability
29	IO26	Digital I/O Analog	General purpose I/O Analog capability
30	IO27	Digital I/O Analog	General purpose I/O Analog capability
31	IO28	Digital I/O Analog	General purpose I/O Analog capability
32	IO29	Digital I/O Analog	General purpose I/O Analog capability
33	IO30	Digital I/O Analog	General purpose I/O Analog capability
34	IO0	Digital I/O	General purpose I/O
35	IO1	Digital I/O	General purpose I/O
36	IO2	Digital I/O	General purpose I/O

**Note:** Please refer to [TI CC2642R Datasheet](#) for detailed descriptions and features supported about the Pin assignments.

## 5. Mounting Suggestion

You can refer to the following references for the mounting design of **MK11A**.

**Recommended module mounting example:**

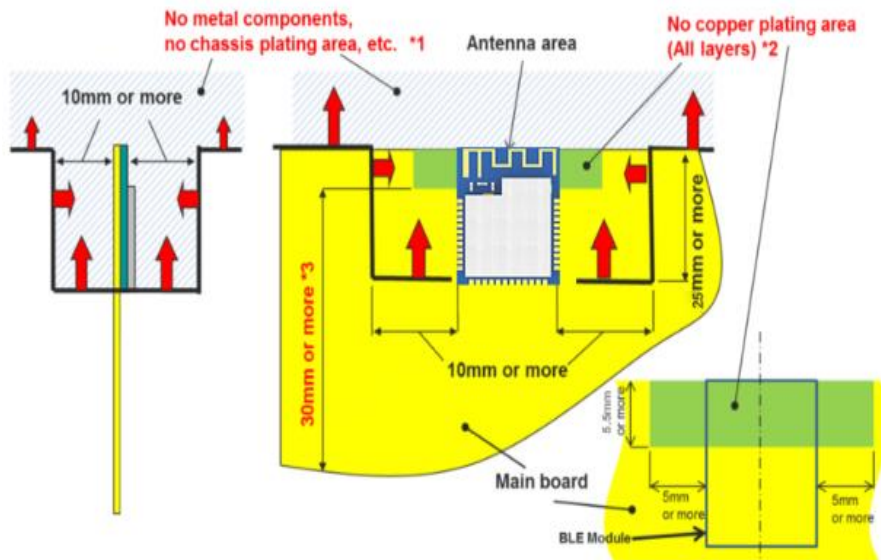

- Please do not place any metal components in blue shaded space (\*1), such as signal line and metal chassis as possible except for main board while mounting the components in \*1 space on the main board is allowed except for no copper plating area (\*2).
- (\*2) This area is routing prohibited area on the main board. Please do not place copper on any layer.
- (\*3) Characteristics may deteriorate when GND pattern length is less than 30mm. It should be 30 mm or more as possible.
- For the best Bluetooth range performance, the antenna area of module shall extend 3 mm outside the edge of main board, or 3 mm outside the edge of a ground plane. Ground plane shall be at least 5 mm from the edge of the antenna area of module.
- All module GND pins MUST be connected to main board GND. Place GND vias close to module GND pads as possible. Unused PCB area on surface layer can flooded with copper but place GND vias regularly to connect copper flood to inner GND plane. If GND flood copper underside the module then connect with GND vias to inner GND plane.
- Even when above mentioned condition is satisfied, communication performance may be significantly deteriorated depending on the structure of the product. Bluetooth range performance is degraded if a module is placed in the middle of the main board.
- For main board layout:
  - Avoid running any signal line below module whenever possible.
  - No ground plane below antenna.
  - If possible, cut-off the portion of main board below antenna.

# MK11A Bluetooth Module

## Datasheet

### Other module mounting examples:

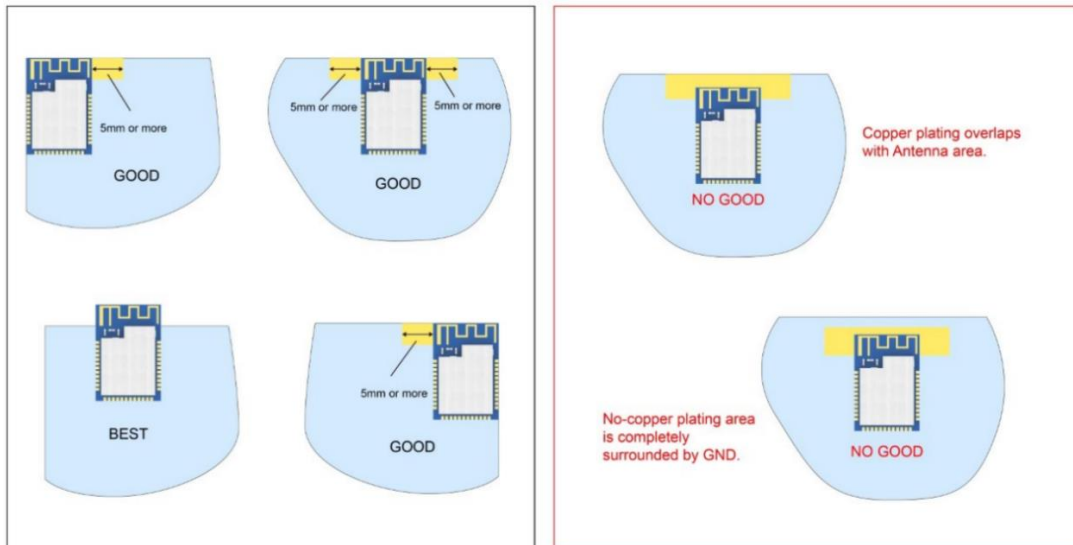

### Placement of resin or plastic parts:

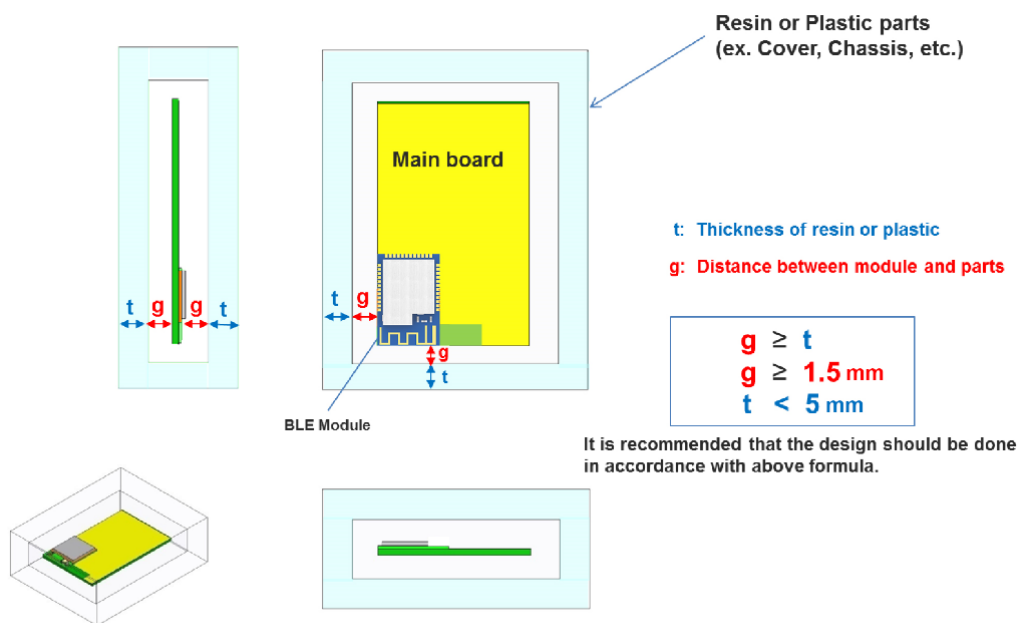

Please do not apply molding over the antenna area of BLE module.

### Placement of metal parts

- Minimum safe distance for metal parts without seriously compromising the antenna (tuning) is 40 mm top/bottom and 30 mm left or right.
- Metal close to the module antenna (bottom, top, left, right, any direction) will have degradation on the antenna performance. The amount of that degradation is entirely system dependent, meaning you will need to perform some testing with your host application.
- Any metal closer than 20 mm will begin to significantly degrade performance (S11, gain, radiation efficiency).
- It is best that you test the range with a mock-up (or actual prototype) of the product to assess effects of enclosure height (and materials, whether metal or plastic).

## 6. Qualification and approvals

### 6.1 United States (FCC)

The MK11 has received Federal Communications Commission (FCC) CFR47 Telecommunications, Part 15 Subpart C “Intentional Radiators” modular approval in accordance with Part 15.247 Modular Transmitter approval. The modular approval allows the end user to integrate the module into a finished product without obtaining subsequent and separate FCC approvals for intentional radiation, provided no changes or modifications are made to the module circuitry. Changes or modifications could void the user’s authority to operate the equipment. The end user must comply with all of the instructions provided by the Grantee, which indicate installation and/or operating conditions necessary for compliance.

The finished product is required to comply with all applicable FCC equipment authorizations regulations, requirements and equipment functions not associated with the transmitter module portion. For example, compliance must be demonstrated to regulations for other transmitter components within the host product; to requirements for unintentional radiators (Part 15 Subpart B “Unintentional Radiators”), such as digital devices, computer peripherals, radio receivers, etc.; and to additional authorization requirements for the non-transmitter functions on the transmitter module (i.e., Verification, or Declaration of Conformity) (e.g., transmitter modules may also contain digital logic functions) as appropriate.

**Note:**

Modification to this product will void the users’ authority to operate this equipment.

The OEM is still responsible for verifying end product compliance with FCC Part 15, subpart B limits for unintentional radiators through an accredited test facility.

#### 6.1.1 Labeling and user information requirements

**The MK11 is assigned the FCC ID number: 2A094-MK11**

If the FCC ID is not visible when the module is installed inside another device, then the outside of the finished product into which the module is installed must also display a label referring to the enclosed module. This exterior label can use the following or similar wording:

Contains FCC ID: 2A094-MK11

In addition to marking the product with the appropriate FCC ID, the end product user manual may also require specific information based on the digital device classification. Refer to the [FCC Rules, Title 47, Subchapter A, Part 15, Subpart B, Chapter §15.105](#) for specific wording of the notices.

#### 6.1.2 RF exposure

All transmitters regulated by FCC must comply with RF exposure requirements. [KDB 447498 General RF Exposure Guidance](#) provides guidance in determining whether proposed or existing transmitting facilities, operations or devices comply with limits for human exposure to Radio Frequency (RF) fields adopted by the Federal Communications Commission (FCC).

This module is approved for installation into mobile and/or portable host platforms and must not be co-located or operating in conjunction with any other antenna or transmitter except in accordance

# MK11A Bluetooth Module

## Datasheet

with FCC multi-transmitter guidelines. End users must be provided with transmitter operating conditions for satisfying RF Exposure compliance.

## 6.2 European Union regulatory compliance

Information about regulatory compliance of the European Union for the MK11 module is available in the MK11 Declaration of Conformity.

### 6.2.1 Radio Equipment Directive (RED) 2014/53/EU

The MK11 module complies with the essential requirements and other relevant provisions of Radio Equipment Directive (RED) 2014/53/EU.

### 6.2.2 Labeling and user information requirements

The label on the final products which contain the MK11 module must follow CE marking requirements. The “R&TTE Compliance Association Technical Guidance Note 01” provides guidance on final product CE marking.

## 7. Cautions

### 7.1 Reflow Soldering

Reflow soldering is a vitally important step in the SMT process. The temperature curve associated with the reflow is an essential parameter to control to ensure the correct connection of parts. The parameters of certain components will also directly impact the temperature curve selected for this step in the process.

#### Temperature-Time Profile for Reflow Soldering:

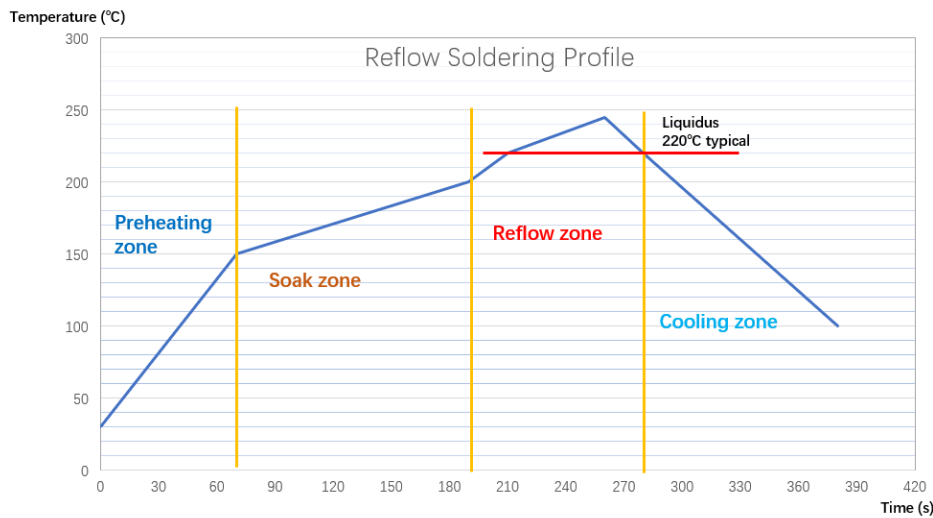

- The standard reflow profile has four zones: ①preheat, ②soak, ③reflow, ④cooling. The profile describes the ideal temperature curve of the top layer of the PCB.
- During reflow, modules should not be above 260°C and not for more than 30 seconds.

Specification	Value
Temperature Increase Rate	<2.5°C/s
Temperature Decrease Rate	Free air cooling
Preheat Temperature	0-150°C
Preheat Period (Typical)	40-90s
Soak Temp Increase Rate	0.4-1°C/s
Soak Temperature	150-200°C
Soak Period	60-120s
Liquidus Temperature (SAC305)	220°C
Time Above Liquidous	45-90s
Reflow Temperature	230-250°C
Absolute Peak Temperature	260°C



# MK11A Bluetooth Module

## Datasheet

Example of MOKO SMT reflow soldering:

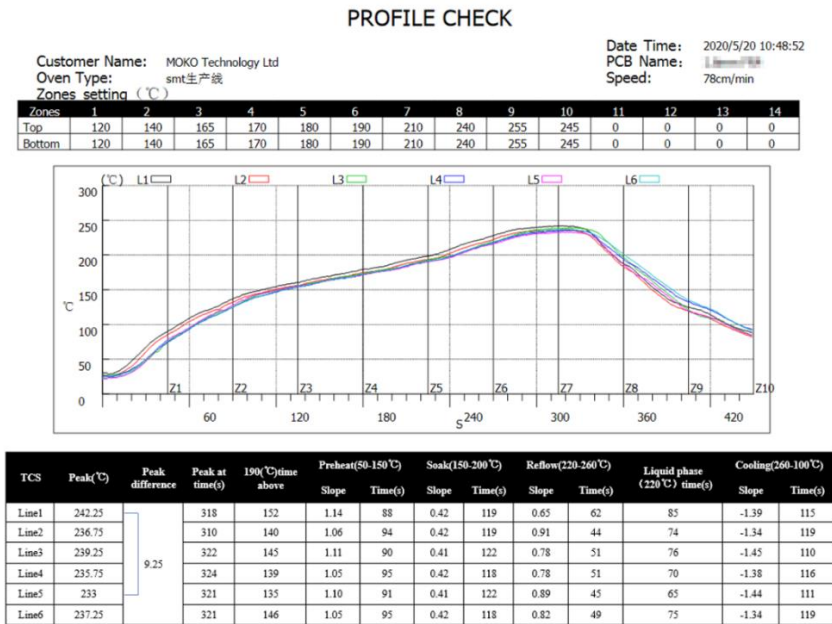

**Note:** The module is LGA package. Please be careful of the amount of solder paste. The module may be lifted due to excess solder.

## 7.2 Usage Condition Notes

- Follow the conditions written in this specification, especially the recommended condition ratings about the power supply applied to this product.
- The supply voltage has to be free of AC ripple voltage (for example from a battery or a low noise regulator output). For noisy supply voltages, provide a decoupling circuit (for example a ferrite in series connection and a bypass capacitor to ground of at least 47uF directly at the module).
- Take measures to protect the unit against static electricity. If pulses or other transient loads (a large load applied in a short time) are applied to the products, check and evaluate their operation before assembly on the final products.
- The supply voltage should not be exceedingly high or reversed. It should not carry noise and/or spikes.
- This product away from other high frequency circuits.
- Keep this product away from heat. Heat is the major cause of decreasing the life of these products.
- Avoid assembly and use of the target equipment in conditions where the products' temperature may exceed the maximum tolerance.
- This product should not be mechanically stressed when installed.
- Do not use dropped products.
- Do not touch, damage or soil the pins.
- Pressing on parts of the metal shield or fastening objects to the metal shield will cause damage.

### 7.3 Storage Notes

- The module should not be stressed mechanically during storage.
- Do not store these products in the following conditions or the performance characteristics of the product, such as RF performance will be adversely affected:
  - Storage in salty air or in an environment with a high concentration of corrosive gas.
  - Storage in direct sunlight
  - Storage in an environment where the temperature may be outside the range specified.
  - Storage of the products for more than one year after the date of delivery storage period.
- Keep this product away from water, poisonous gas and corrosive gas.
- This product should not be stressed or shocked when transported.

### Revision History

Revision	Description of changes	Approved	Revision Date
V1.0	Initial Release	Kevin	2020.09.04
V1.1	Updated Section 1.3	Victor	2020.10.15
V1.2	Added Section 6 Qualification and approvals	Victor	2021.01.14

# MK11A Bluetooth Module

## Datasheet

The contents of this datasheet are subject to change without prior notice for further improvement. MOKO team reserves all the rights for the final explanation.

Please contact MOKO sales team or visit <https://www.mokoblue.com> to get more related information if needed.

## MOKO TECHNOLOGY LTD.

 4F,Buidling2, Guanghui Technology Park,  
MinQing Rd, Longhua, Shenzhen, Guangdong, China

 Tel:86-755-23573370-829

 Support\_BLE@mokotechnology.com

 <https://www.mokoblue.com>

